

# Dynamic Rheological Properties of Bread Crumb. I. Effects of Storage Time, Temperature, and Position in the Loaf<sup>1</sup>

J. N. PERSAUD,<sup>2</sup> J. M. FAUBION,<sup>2</sup> and J. G. PONTE, JR.<sup>2</sup>

## ABSTRACT

Cereal Chem. 67(1):92-96

The dynamic rheological properties  $G'$ ,  $G''$ , and loss tangent of the crumb of white pan bread were characterized at ambient temperature during the first 120 hr after baking. Linear viscoelastic behavior was observed up to 0.6% (peak-to-peak) strain. Above 0.6% strain,  $G''$  of the 3-hr-old crumb increased with increasing strains. This strain dependency shifted to higher levels after 24 hr and longer, except when storage was at 45°C. The changes in  $G'$  with age when stored at 4, 25, and 45°C showed trends similar to the firmness curves obtained using empirical static compression tests. Changes in both  $G'$  and  $G''$  with aging

were temperature-dependent processes. As the storage temperature increased, the rate of increase in  $G'$  relative to  $G''$  was lowered such that, at 45°C, the tangent of the 120-hr old crumb was the same as that of crumb aged 3 hr.  $G'$  values of the middle slice became higher than those of the end slices as the storage temperature was reduced. Dynamic tests did not detect any significant differences in the rates or extent of change of either  $G'$  or tangent because of the plane of shearing. Two commercial bread flours had different  $G'$  values, but the difference was the same at all crumb ages.

Crumb firming is one of the most important attributes of bread staling. It is also the simplest to define objectively (Willhoft 1973). With the exception of compressibility of the isolated cell wall material (Guy and Wren 1968) and bulk modulus (Willhoft 1971), the methods and instruments used to objectively evaluate bread crumb texture involve uniaxial compression between parallel plates (Ponte and Faubion 1985). Lasztity (1980) summarized the problems in presenting rheological data in absolute units when bread crumb is subjected to such large deforming forces. Hibberd and Parker (1985) pointed to the difficulties in comparing and interpreting data obtained by different instruments on a viscoelastic material like bread crumb, where the applied force is not linearly related to strain or time effects.

Dynamic stress-strain tests have been used successfully to describe the material properties of synthetic polymer systems, including cellular foams (Meinecke and Clark 1973, Hilyard 1985). Dynamic tests also can be used on foods if a test sample of simple geometry can be obtained (Rao 1984). Bread crumb has an open cellular structure (Taranto 1983), contains the biopolymers gluten and starch, and it is easy to prepare a rectangular block section.

Several studies of the dynamic rheological properties of flour-water dough systems have been carried out over the past two decades (Hibberd and Wallace 1966, Dreese et al 1988). Most recently, Dreese et al (1988) studied heated flour-water doughs, whereas Abdelrahman and Wollerman (1988) studied the fermenting dough. In this research, the properties of freshly baked and aged bread crumb were characterized using dynamic stress-strain measurements in simple shear.

## MATERIALS AND METHODS

The rheometer used in these experiments was the same instrument previously described and used by Dreese (1987) and Dreese et al (1988) for dough rheological studies. These references provide detailed descriptions of its construction, operation, and calibration. Therefore, discussions of the instrumentation and procedure will be confined to those specific adaptations made for dynamic stress-strain measurements of bread crumb.

To prevent dehydration of the crumb during measurement, an atmosphere of  $94 \pm 3\%$  relative humidity and  $80 \pm 1^\circ\text{F}$  was used. These values were selected because the water activity ( $a_w$ ) of the crumb from zero to seven days old was  $0.93 \pm 0.02$ . To attain these conditions, the sample holder, shaker, force transducer, and linear variable displacement transformer were placed

in a cabinet (TMCO, National Mfg., Lincoln, NE) with humidity and temperature controls.

Like synthetic foams, bread crumb has to be glued onto the testing plates to eliminate slippage between the sample and the oscillating plate. To simplify cleaning between sample runs, the testing plates were lined with 1-mm thick aluminum plates, which were held by screws at the four corners. In loading the sample, a uniform, thin film of Duro super glue (gel type) (Loctite Corp.) was spread on the top testing plate, after which the rectangular block crumb section was set on the resin. To ensure uniform contact, a spare 1-mm aluminum plate was placed on the exposed upper surface, and a finger pressure of 10–15 grams of force was applied for 10 sec. After gluing, the top plate with the sample was placed in the controlled humidity cabinet. The bottom plate was mounted in the rheometer and spread with a film of resin. The top plate (with the sample) was then fixed by a screw onto the shaker, slightly loosened, and gently lowered to the bottom plate, so that the sample set evenly without being compressed. After 10 sec, the screw fixing the top plate to the shaker was once again tightened, and the sample was allowed to rest for 5 min to reestablish temperature and humidity before measurements were taken.

The bread used for all analyses was made by a straight-dough procedure from the formula in Table I. It was optimized to produce 475-g loaves with right-side break, small core, and grain of uniform white color. Commercial bread flours used were from Ross Mills (Ross Industries, Wichita, KS) and Archer-Daniels Midlands (ADM Milling Co., Salina, KS). The Ross Mills flour contained 11.8% protein and 0.48% ash (14% mb). The ADM flour contained 11.3% protein and 0.47% ash (14% mb). Other ingredients included shortening (Richtex, Kraft Inc.), instant active dried yeast (Gist-Brocades, Delft, Holland), heat-treated and powdered nonfat dried milk (Galloway West, WI), white crystalline sucrose (American Crystal Sugar, Co.), ascorbic acid (Fischer Scientific, Fairlawn, NJ), table grade sodium chloride, and distilled water. The baking pans were greased with all-purpose shortening.

TABLE I  
Basic Bread Formula<sup>a</sup>

| Ingredients       | Weight (g) | Baker's % |
|-------------------|------------|-----------|
| Flour             | 320.0      | 100       |
| Sucrose           | 19.2       | 6         |
| Sodium chloride   | 6.4        | 2         |
| Nonfat dried milk | 9.6        | 3         |
| Shortening        | 9.6        | 3         |
| Yeast             | 3.2        | 1         |
| Water             | 204.8      | 64        |
| Ascorbic acid     | 10 ppm     | 0.001     |

<sup>a</sup>"No shortening" loaves were made with formula minus the shortening.

<sup>1</sup>Contribution no. 89-192-J. Kansas Agricultural Experiment Station.

<sup>2</sup>Research associate, associate professor, and professor, respectively, Department of Grain Science and Industry, Kansas State University, Manhattan 66506.

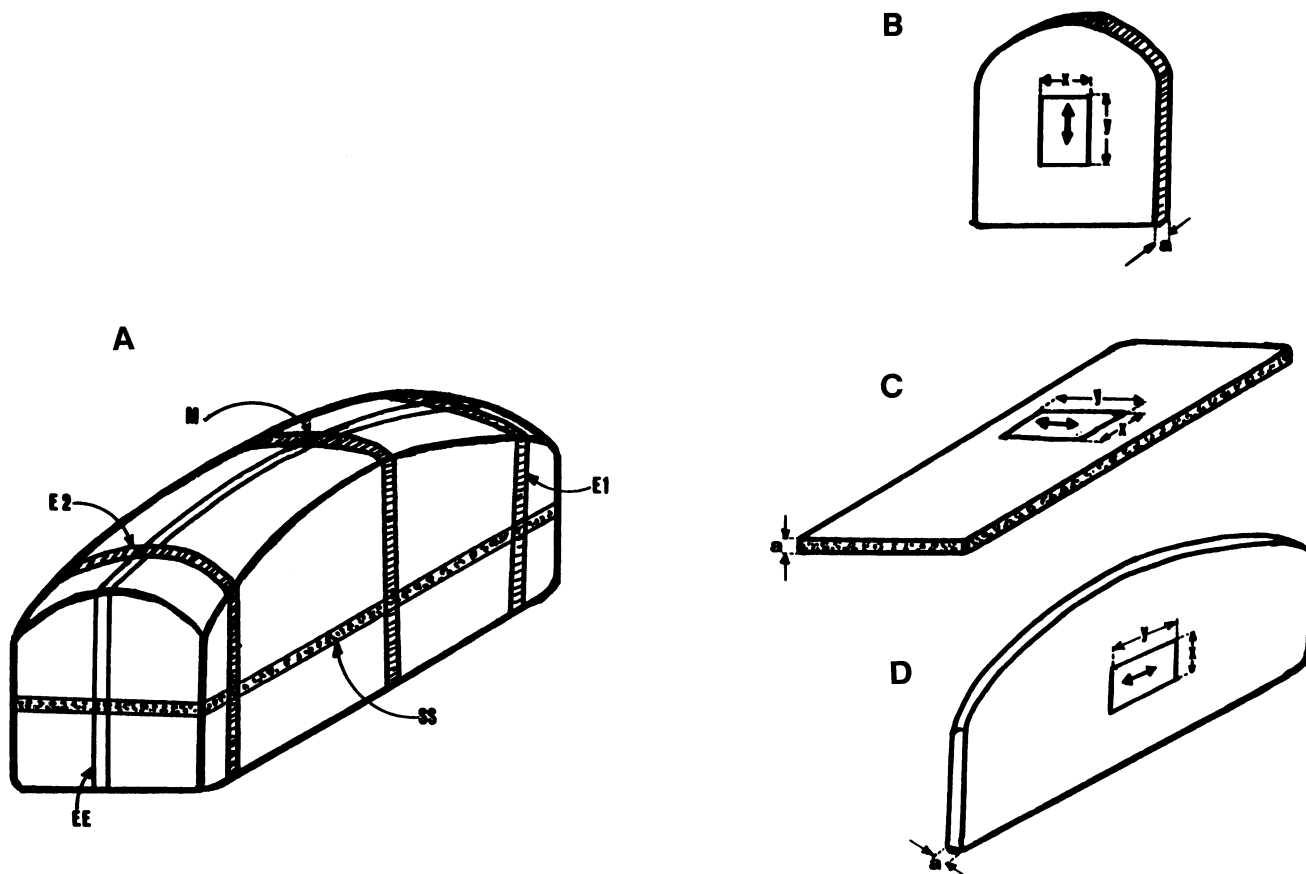

Fig. 1. A, Whole loaf indicating three slicing planes: E1 and E2, slices 4.5 cm from end; M, cross-sectional center slice; SS, horizontal center slice parallel to long axis of the loaf; EE, vertical center slice parallel to long axis of the loaf. B, Slices E1, E2, or M with top-bottom shearing; C, Slice SS with side-to-side shearing; D, slice EE with end-to-end shearing. Rectangular blocks were taken as indicated: width ( $x$ ) = 45 mm, length ( $y$ ) = 60 mm, and thickness ( $a$ ) = 11–13 mm.

All freshly baked loaves were cooled at least 1 hr before slicing when freshly made bread was studied. For the effects of temperature during aging studies, loaves were sealed in double polyethylene bags and stored at 4, 25, or 45°C up to 120 hr. In all other studies, aging was at 25°C for up to 120 hr. Except where other planes of shear were studied, the loaves were sliced cross-sectionally 11–13 mm thick (Fig. 1A and B), with uniform parallel surfaces, using an Oliver slicer (Oliver Machinery Co., Grand Rapids, MI). At this thickness, there is negligible sample inertia at the frequency of oscillation (5 Hz) used. A rectangular block of crumb 60 × 45 mm was taken from the center of the slice. Shearing was done “top-bottom” (parallel to the longer side,  $y$  in Fig. 1B) in the slice. When comparing the effects of shear plane orientation, two other planes of shear, i.e., “side-side” (Fig. 1A and C) and “end-end” (Fig. 1A and D) were used. Within 30 sec of preparation, the rectangular block section was placed in a 25 × 15 cm Zip-Loc polyethylene bag to minimize moisture loss before measurement was made.

## RESULTS AND DISCUSSION

The data from the rheometer were used to calculate  $G'$ , the shear storage modulus (elastic component),  $G''$ , the shear loss modulus (viscous component), and  $G''/G'$ , the loss tangent (Dreese 1987). The results are presented as plots of  $\log G'$  (A in Figs. 2–8) or tangent (B in Figs. 2–8) versus strain or crumb age at 0.2% strain. Each point on the plots is the mean of at least three independent determinations, and 95% confidence interval error bars are indicated.

### Strain Dependence

To calculate the above rheological parameters, the viscoelastic behavior of the sample was assumed to be linear, i.e., the ratio

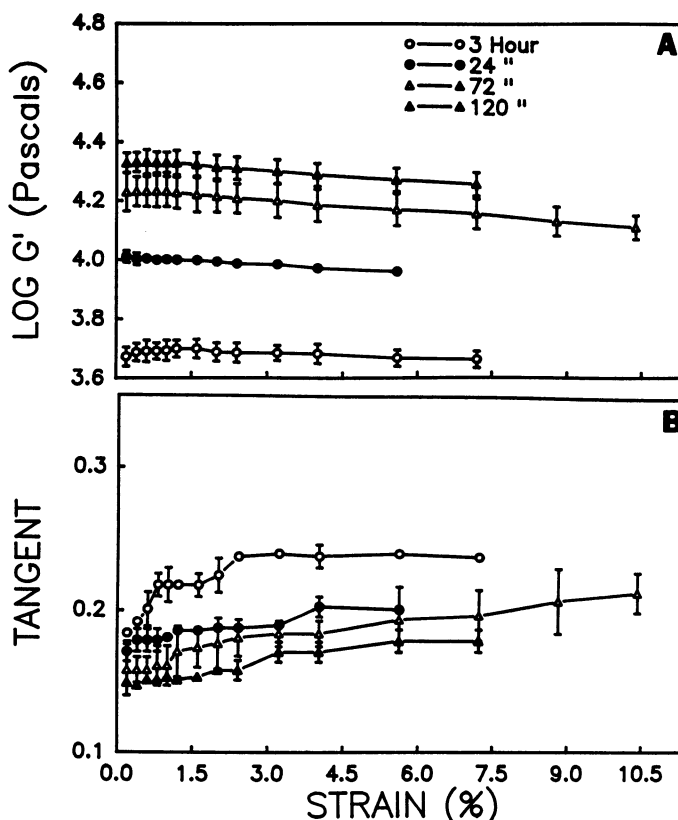

Fig. 2. Strain scans in simple shear at 25°C and 5 Hz of bread crumb from loaves aged from 3 to 120 hr at 25°C. A middle slice (M in Fig. 1) was tested.

of stress to strain is a function of time (frequency) alone (Ferry 1980). Therefore, strain scans were done to establish the linear response region for bread crumb made with the basic bread formula. Bread crumb was surprisingly linear in its behavior. In Figure 2A, it is clear that, for each age,  $G'$  did not change

with increasing strain up to the maximum level achieved. This behavior was also true for bread made with the basic formula minus shortening as well as for the end slices.  $G'$  of crumb from bread stored at 4 and 45°C also did not display any strain dependence (data not shown).

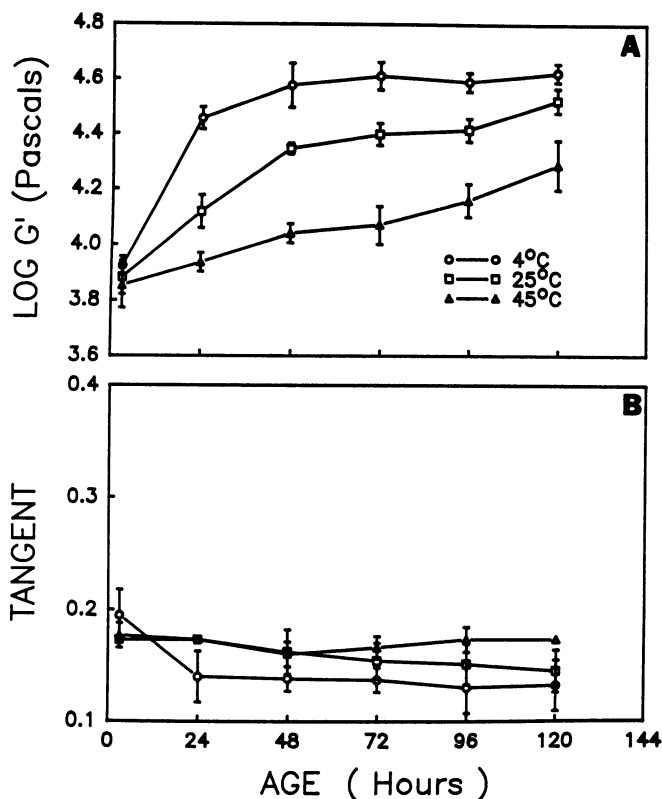

Fig. 3. Effects of storage at 4, 25, and 45°C on log  $G'$  and tangent of bread crumb. A section from the middle slice was sheared at 0.2% strain and 5 Hz.

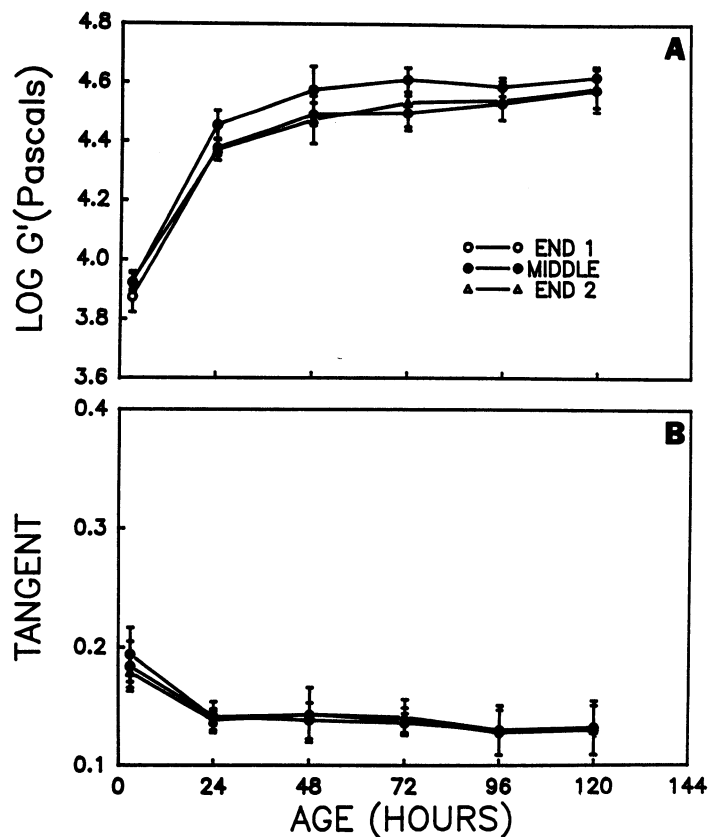

Fig. 5. Comparison of the two ends (E1 and E2) and middle (M) slices at 0.2% strain. Loaves were aged at 4°C. Shearing was at 5 Hz.

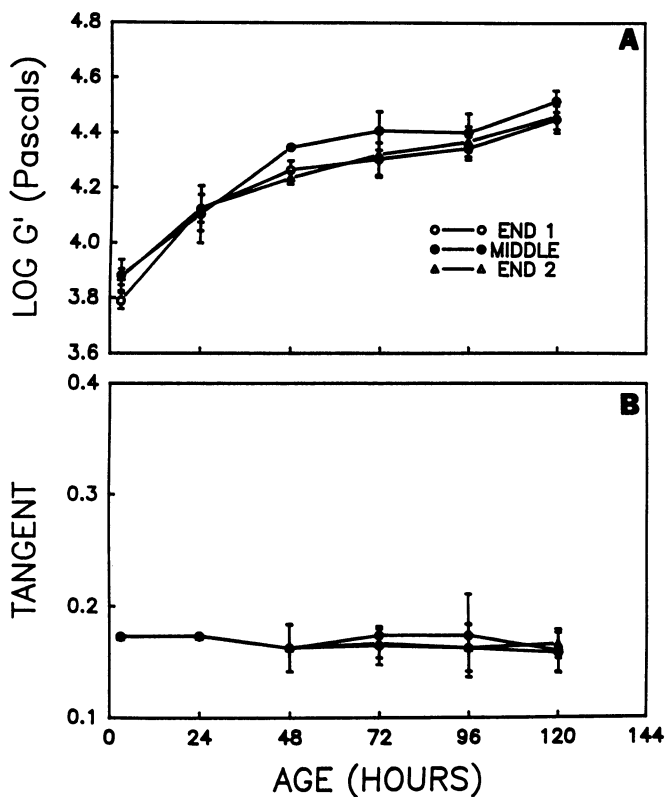

Fig. 4. Comparison of the two ends (E1 and E2) and middle (M) slices at 0.2% strain. Loaves were aged at 25°C. Shearing was at 5 Hz.

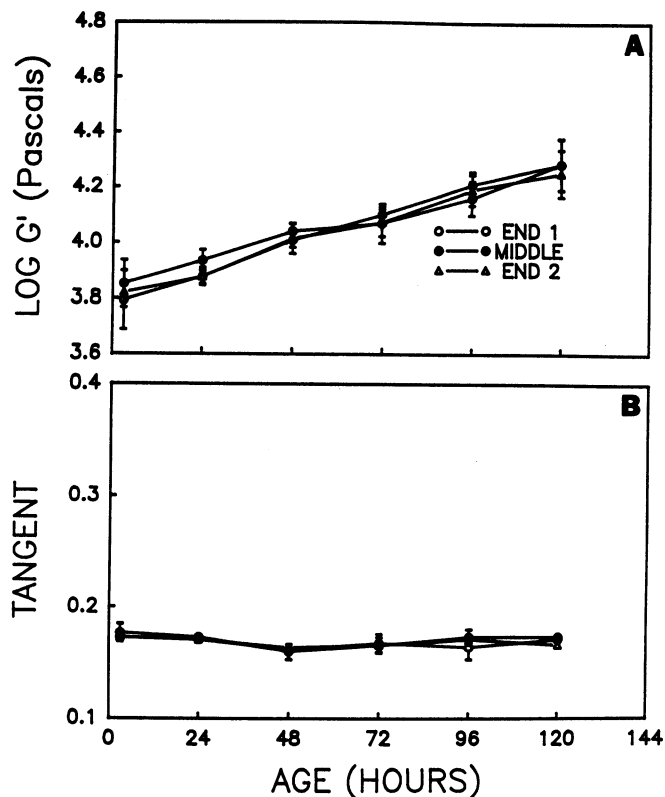

Fig. 6. Comparison of the two ends (E1 and E2) and middle (M) slices at 0.2% strain. Loaves were aged at 45°C, and shearing was at 5 Hz.

Tangent plots from the same studies (Fig. 2B, other plots not shown) reveal that the tangent of the 3-hr-old crumb did not vary significantly with strain up to levels of 0.6%. Samples that were aged longer were strain independent up to 4% (Fig. 2B). For the 3-hr-old crumb, there was a significant increase in the tangent beyond 0.6% strain. This was seen in all three positions in the loaf. Because  $G'$  remained unchanged, these results indicate that, in the 3-hr-old crumb, there is an as yet unidentified factor that causes the viscous component of the response ( $G''$ ) to change positively with strain. Whatever this factor is, its contribution is reduced as the crumb ages, becoming apparent only at higher strain levels. The effect of strain on the tangent of crumb stored at 4°C was similar to that at 25°C, but at 45°C there was a small increase in tangent above 0.6% strain at all ages (data not shown).

Thus, up to 0.6% strain for the 3-hr-old crumb, both  $G'$  and  $G''$  are strain independent. For older crumb, the linear range was extended to higher strains.

#### Effects of Aging Temperature

Figure 3A plots  $\log G'$  versus time for the middle slices from loaves aged at 4, 25, and 45°C. Clearly, the extent and patterns of change in  $G'$  were not the same at each storage temperature. At 45°C, the rate of increase in  $\log G'$  was linear over the entire 120 hr of storage. At 25°C,  $\log G'$  increased almost linearly up to 48 hr but at a rate greater than at 45°C. However, beyond 48 hr, the two had nearly parallel rates of change of  $G'$ . At 4°C,  $G'$  increased at the most rapid rate during the first 24 hr of storage. The subsequent change in rate of increase was close to that at 45°C. The changes in  $G'$  with age at the different storage temperatures followed a pattern generally similar to those obtained for firmness obtained by current empirical methods of compression between parallel plates (Maga 1975, Stellar and Bailey 1938).

As illustrated in Figure 3B, the tangents of crumb stored at 25 and 45°C were similar for up to 48 hr. During aging at 4°C, there was a rapid drop in tangent from 3 to 24 hr, after which the values remained constant for the rest of the storage period.

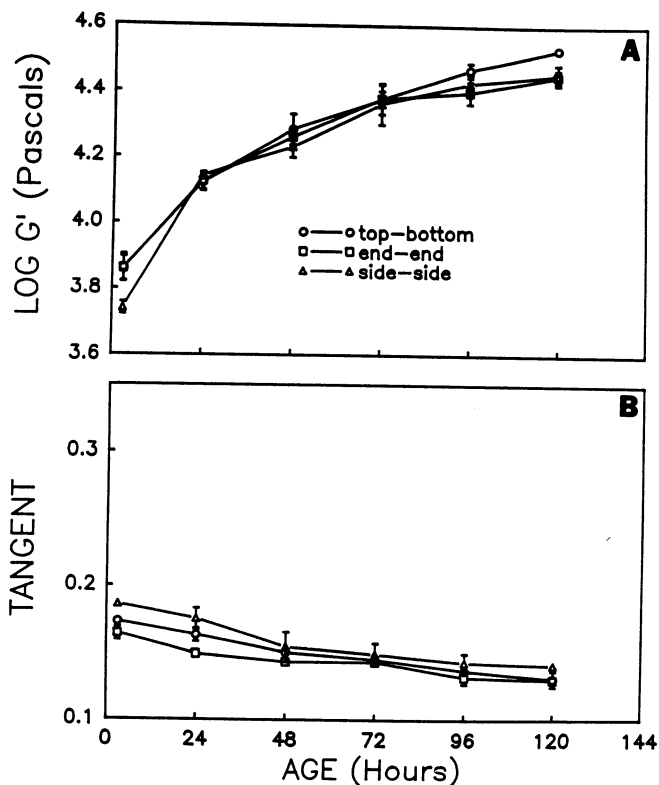

Fig. 7. Effects of shearing in different planes. Details are presented in Materials and Methods. Sections from the center of loaves aged at 25°C were measured at 5 Hz and 0.2% strain.

Interestingly, beyond 48 hr, the tangent of the crumb stored at 25°C approached the values of crumb aged at 4°C. Clearly, aging changes both the elastic ( $G'$ ) and viscous ( $G''$ ) components of the crumb's response to deformation. These changes are temperature dependent. However, the rates of change of each are different, such that at 45°C the tangent remains constant throughout the aging period. On the other hand, as the storage temperature is lowered, the elastic component,  $G'$ , increases faster relative to  $G''$ , resulting in a net decrease in tangent during aging.

In polymer systems, increasing  $G'$  and decreasing tangent such as observed here can indicate the development of, or an increase in, cross-linking (Ferry 1980). It is known that starch retrogradation occurs during crumb aging. In partially crystalline polymers, crystallites may act as cross-links. The behavior of bread crumb's  $G'$  and tangent during storage at 25 and 4°C may appear to support this. However, at 45°C, ( $\sim 8^\circ\text{C}$  below the melting point of retrograded starch crystallites), annealing should be near maximum at this temperature (Yost and Hosney 1986), and an even higher  $G'$  would be predicted. This was not observed (Fig. 3), and it seems unlikely that starch retrogradation causes the increased rigidity in the crumb matrix. Furthermore,  $G''$  increases positively with strain for aged crumb above a level of 4%. It is unlikely that this is due to breaking of the crystallites. Hence, it appears that the increased rigidity and reduced flow observed in the aging crumb is due to the development of cross-links or aggregates other than starch crystallites.

#### Effect of Position in the Loaf

Other workers (Ponte et al 1962, Redlinger et al 1985) reported differences in crumb firming related to position in the loaf. We compared end and middle slices at 0.2% strain (Fig. 4A). At 25°C, the middle slice had a higher  $G'$  after 48 hr. At 4°C (Fig. 5A), this difference was apparent after only 24 hr of storage. At 45°C (Fig. 6A), there was no difference in the  $G'$  of slices from the three positions. Although the change in  $G'$  was unique to each storage temperature, there was a difference between the end and middle slices. This difference increased as the storage

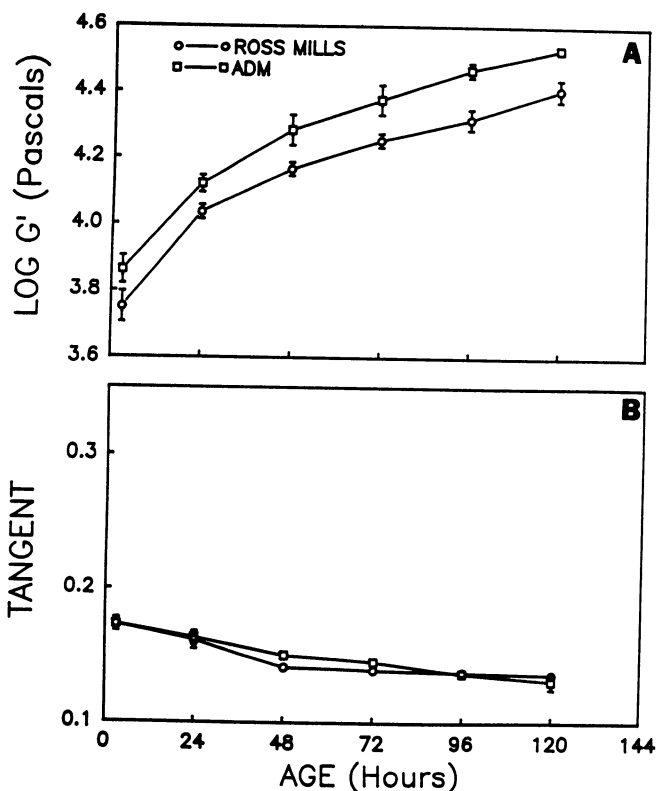

Fig. 8. Comparison of bread crumb made from Ross Mills and ADM flours. Sections from middle slices of loaves aged up to 120 hr at 25°C were sheared at 5 Hz and 0.2% strain.

temperature was lowered or, as seen in Figures 4–6, when the log  $G'$  value exceeded 4.2. Ponte et al (1962) showed that the density of the crumb in the center of the loaf is higher than at the ends. It appears, therefore, that the effect of density on  $G'$  becomes significant only after rigidity has reached a specific value.

The loss tangent of the crumb stored at 45°C did not change significantly over the entire aging period (Fig. 6B), and there was no difference among the three positions in the loaf. At 4°C (Fig. 5B) and 25°C (Fig. 4B), the end and middle slices did not show different tangent values either. However, there was greater variability in the tangent at these two temperatures compared with those measured after storage at 45°C.

#### Effect of Shear Plane Orientation

The grain of white pan bread made by the straight dough procedure consists of small round cells in the core of the crumb surrounded by elongated cells of increasing density approaching the crust (Shogren and Finney 1984). This indicates that firmness measurement may vary according to the plane of deformation, i.e., the crumb would be anisotropic. Hibberd and Parker (1985) found anisotropy in the crumb of loaves whose oven spring was forcibly limited. To examine for anisotropy with dynamic testing, sections taken from the center of loaves were sheared in three planes perpendicular to each other (described in Materials and Methods).

Side-to-side shearing resulted in the lowest  $G'$  for 3-hr-old bread (Fig. 7A). However, after 24 hr,  $G'$  was the same for all three planes of shear. Three-hour-old crumb that was sheared from side to side had the highest tangent (Fig. 7B). After 24 hr, the tangents of the crumb in all planes of shear were equivalent. Strain scans in all planes were similar.

A possible explanation for this apparent lack of anisotropy after 3 or 24 hr is that sample sections were taken from the center of the loaves where the cells are most spherical. Thus, the surface presented in all planes was similar, so the resistance to deformation in all planes also was similar. This would act to reduce or eliminate any anisotropy. These data also may indicate that there is no specific molecular orientation of the polymers in the crumb matrix, because shearing parallel and perpendicular to any plane of alignment of molecules will produce anisotropy (Hilyard 1985). Hibberd and Parker (1985), using the Instron universal testing machine on breads in which the oven spring was limited by a pan lid, found differences in the three planes when deformation was greater than 3%. In a system in which oven spring of the loaf was limited, the cell structure would be different from that of a normally baked loaf and, therefore, could be the cause of the observed anisotropy.

#### Comparison of Two Flours

Changes in the rheological properties  $G'$  and tangent of the crumb of bread made with the two flours used in this study during aging at 25°C are shown in Figure 8A, where sections from the middle slices are compared at 0.2% strain. Note the significant difference in  $G'$  between the two flours. Importantly, the rate of firming (change of  $G'$  with time) was the same throughout

the aging period, and the relative difference between the two flours was the same at all ages. Thus, even though the two flours made bread having differing shear storage moduli, whatever factor affects the crumb's firming changed at the same rate for both flours. The viscous component ( $G''$ ) apparently changes in proportion with  $G'$ , because the tangent plot (Fig. 8B) shows no difference between the two flours.

#### LITERATURE CITED

- ABDELRAHMAN, A., and WOLLERMAN, L. 1988. Rheological changes in bread dough during fermentation and baking. (Abstr.) *Cereal Foods World* 33:691.
- DREESE, P. C. 1987. Dynamic rheological studies of flour and gluten doughs. Ph.D. dissertation, Kansas State University, Manhattan, KS.
- DREESE, P. C., FAUBION, J. M., and HOSENEY, R. C. 1988. Dynamic rheological properties of flour, gluten, and gluten-starch doughs. I. Temperature-dependent changes during heating. *Cereal Chem.* 65:348.
- FERRY, J. D. 1980. *Viscoelastic Properties of Polymers*. John Wiley and Sons: New York.
- GUY, R., and WREN, J. 1968. A method for measuring the firmness of the cell wall material of bread. *Chem. Ind. (London)* 68:1727.
- HIBBERD, G. E., and PARKER, N. S. 1985. Measurements of the compression properties of bread crumb. *J. Texture Stud.* 16:97.
- HIBBERD, G. E., and WALLACE, W. 1966. Dynamic viscoelastic behavior of wheat flour doughs. I. Linear aspects. *Rheol. Acta* 5:193.
- HILYARD, N. C. 1985. Dynamic mechanical behavior. Chapt. 4 in: *Mechanics of Cellular Plastics*. MacMillan Publ. Co.: New York.
- LASZTITY, R. 1980. Rheological studies on bread at the Technical University of Budapest. *J. Texture Stud.* 11:81.
- MAGA, J. 1975. Bread Staling. *CRC Crit. Rev. Food Technol.* 5:443.
- MEINECKE, E. A., and CLARK, R. C. 1973. *Mechanical Properties of Polymeric Foams*. Technomic Publishing Co.: Westport, CT.
- PONTE, J. G., and FAUBION, J. M. 1985. Rheology of bread crumb. Page 241 in: *Rheology of Wheat Products*. H. Faridi, ed. Am. Assoc. Cereal Chem.: St. Paul, MN.
- PONTE, J. G., JR., TITCOMB, S. T., and COTTON, R. H. 1962. Flour as a factor in bread firming. *Cereal Chem.* 39:437.
- RAO, V. N. M. 1984. Dynamic force-deformation properties of foods. *Food Technol.* 38(3):103.
- REDLINGER, P. A., SETSER, C. S., and DAYTON, A. D. 1985. Measurements of bread firmness using the Instron universal testing instrument: Differences resulting from test conditions. *Cereal Chem.* 62:223.
- SHOGREN, M. D., and FINNEY, K. 1984. Reproducibility of 100-gram bread volume as affected by correct-side, wrong-side or both sides break and shred. *Cereal Chem.* 61:179.
- STELLER, W. R., and BAILEY, C. H. 1938. The relation of flour strength, soy flour, and temperature of storage to the staling of bread. *Cereal Chem.* 15:391.
- TARANTO, M. V. 1983. Structural and textural characteristics of baked goods. In: *Physical Properties of Foods*. M. Peleg and E. Bagley, eds. Avi Publ. Co.: Westport, CT.
- WILLHOFT, E. 1971. The theory and technique for measuring the firmness of a whole loaf by gaseous compression. *J. Texture Stud.* 2:296.
- WILLHOFT, E. M. A. 1973. Mechanism and theory of staling of bread and baked goods, and associated changes in textural properties. *J. Texture Stud.* 4:292.
- YOST, D. A., and HOSENEY, R. C. 1986. Annealing and glass transition of starch. *Starch/Staerke* 38(9):289.

[Received December 22, 1988. Accepted August 15, 1989.]